



Drilling and milling head, angular, right hand, short
collet chuck, ER50A, PRECI-FLEX®, external and central coolant
supply

číslo součásti 9.911.316
pro Baruffaldi TBMA 320 (60)

poměr 1:1
otáčky na vstupu max. 4000 1/min.
otáčky na výstupu max. 4000 1/min.
Krutící moment max. 200 Nm
Směr otáčení 
Rozsah dodání without wrench and collets

Příslušen. Collets see Equipment for Toolholders Z2.1
Sealing washers see Equipment for Toolholders Z4.1
Wrench for spindle 10008 , 15230
PRECI-FLEX® Adapter
Spindle cover see P99.1
Spindle sealing see P99.1
Coolant tubes 0.001.097

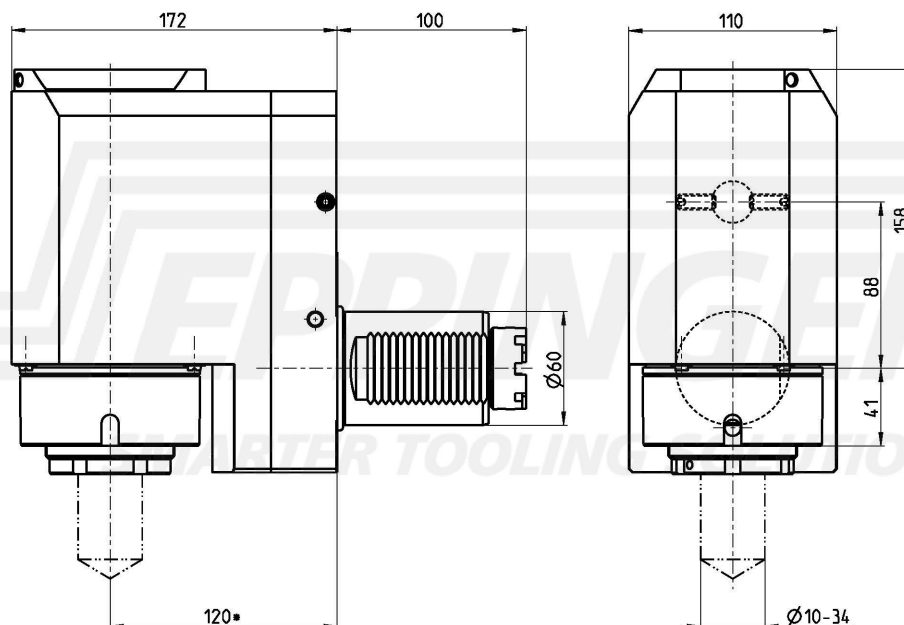

Technické údaje se můžou lišit

08.11.2012 | 08.11.2012