

Cut-off tool holder, direction of rotation universal
external and central coolant supply
tool height H=26

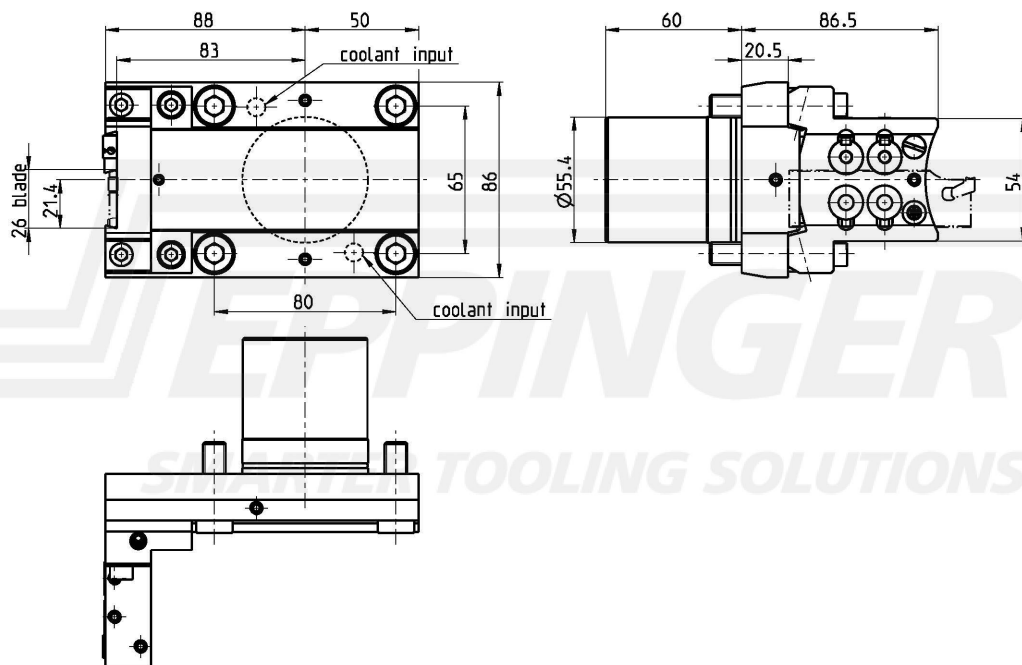

číslo součásti 7.075.570
pro Okuma LT2000EX (V16)



Technické údaje se můžou lišit

02.05.2011 | 02.05.2016